

www.palazzani.it

The new RAGNO generation



RAGNO XTJ 43

43m	18m	330kg	175°	660°	240x70cm	90°+80°	3,6-5,3m	25%	
40%	2,25 km/h	10900kg	75kN	4,06kN/m2	7,12kN/m2	1350mm	8520mm	2280mm	

RAGNO XTJ 43/C

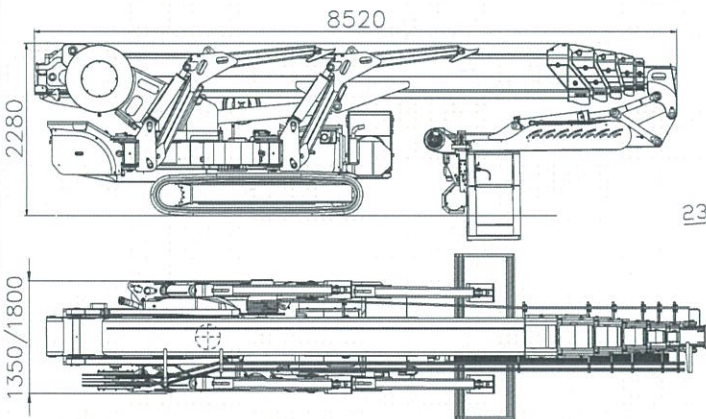
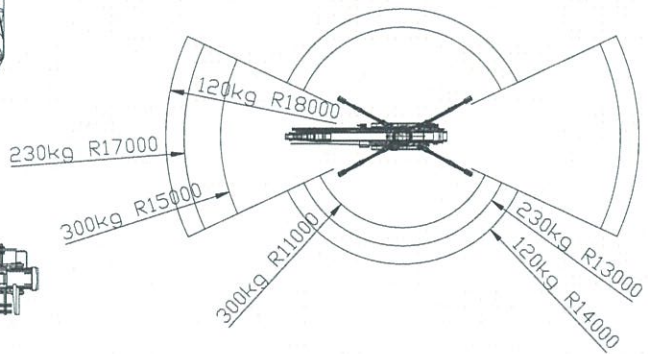
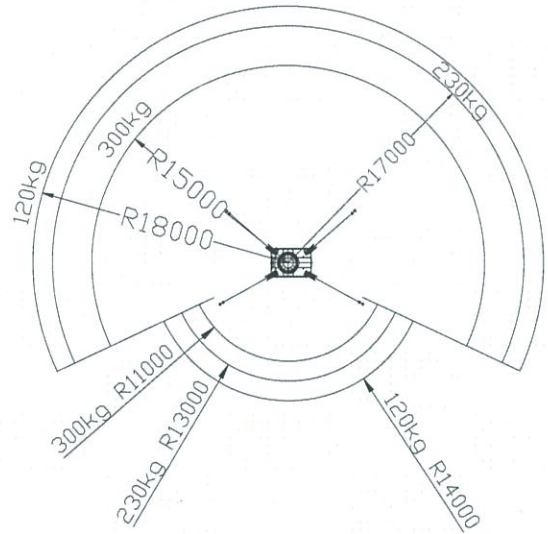
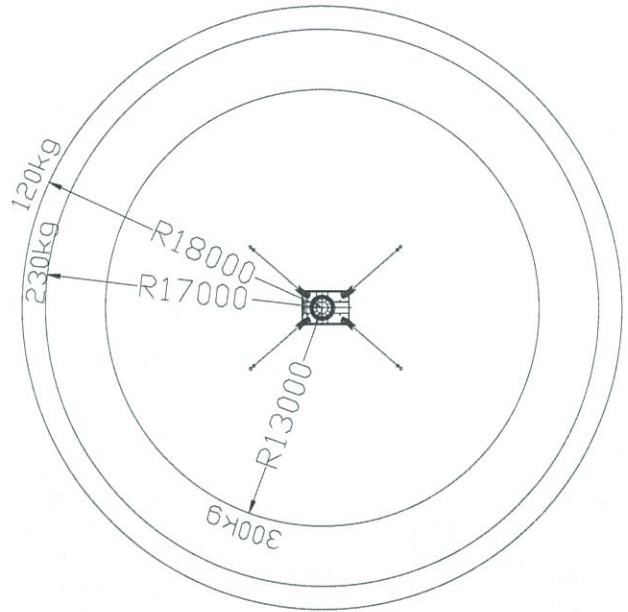
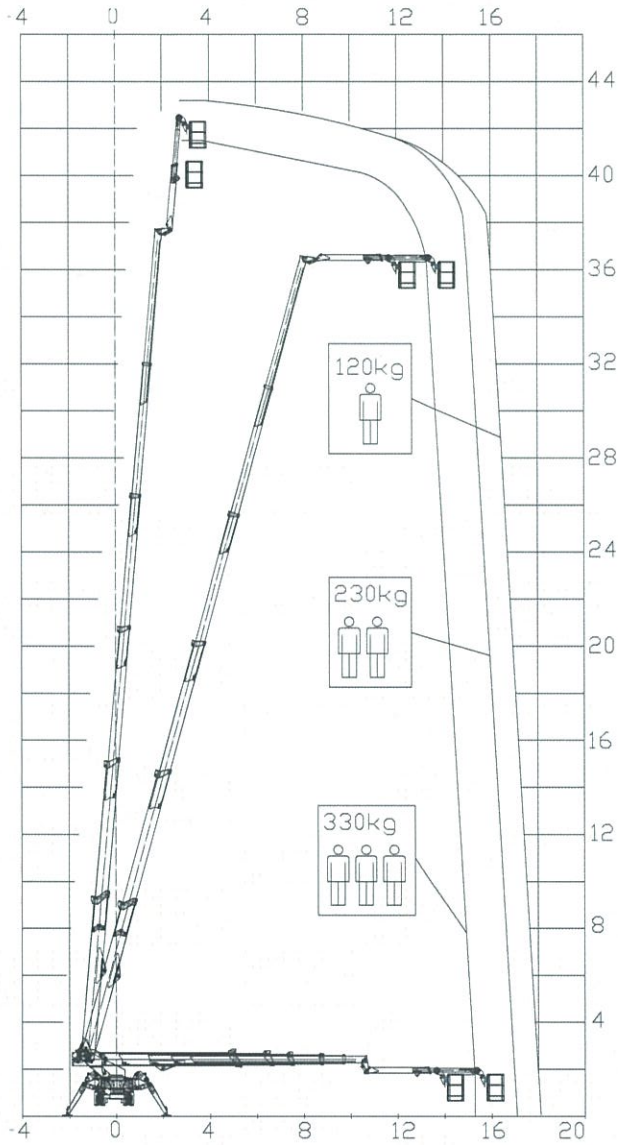

Palazzani
INDUSTRIE

25050 PADERNO F.C. (BS) - ITALY
Tel: ++39 030 6857073 - Fax: ++39 030 657079
www.palazzani.it - platforms@palazzani.it

COMPANY WITH
QUALITY SYSTEM
CERTIFIED BY DNV
= ISO 9001 =

NC 374 A 14

Technical data are informative only and can vary without notice

www.palazzani.it

The new
RAGNO
generation

RAGNO XTJ 42

42 M WORK H.
200-300 KG S.W.L.
ON WHEELS OR RETRACTABLE TRACKS
200-400 KG WIRE WINCH



RAGNO XTJ 42



diagramma variabile in base alla stabilizzazione
working area variable according to set-up configuration



RAGNO XTJ 42/R	MODELLO	MODEL	MODEL	MODELE	RAGNO XTJ 42/C
42 M	ALTEZZA MAX	MAX WORK H.	MAX ARBEITSHÖNE	HAUTEUR MAXI	42 M
20 KW	MOTORE DIESEL	DIESEL ENGINE	DIESEL MOTOR	MOTEUR DIESEL	35 KW
2,2 KW - 230V	MOTORI ELETTRICI	ELECTRIC MOTORS	ELEKTROMOTORS	MOTEUR ELECTRIQUES	2,2 KW - 230V
5,5 KW - 380V					5,5 KW - 380V
25 %	PENDENZA MAX	MAX SLOPE	MAX STEIGFAHIGKEIT	PENTE MAXI	40 %
2,0 KM/H	VELOCITA' MAX	MAX SPEED	MAX GESCHWINDIGKEIT	VITESSE MAXI	1,4 KM/H
360° ENDLESS	ROTAZIONE BRACCIO	TURRET SLEWING	DREHTURM	ROTATION TOURELLE	360° ENDLESS
240X90 CM	NAVICELLA AEREA	AERIAL CAGE	ROTATION AEBEITKORB	PANIER	240X90 CM
90° + 80°	ROTAZIONE NAVICELLA	CAGE ROTATION	KORB SCHWENKEN	ORIENTATION PANIER	90° + 80°
120-200-300 KG	PORTATA UTILE	SAFE WORK LOAD	ZULADUNG	CHARGE UTILE	120-200-300 KG
1.160-1.620 MM	LARGHEZZA (W1-W2)	WIDTH (W1-W2)	BREITE (W1-W2)	LARGEUR (W1-W2)	1.370-1.800 MM
8.200 MM	LUNGHEZZA (L)	LENGTH (L)	BAULÄNGE (L)	LONGUEUR (L)	8.200 MM
2.145 MM	ALTEZZA (H)	HEIGHT (H)	HÖNE (H)	HAUTEUR (H)	2.310 MM
9.400 KG	PESO	WEIGHT	GEWICHT	POIDS	10.200 KG
3.730 MM	PIAZZAMENTO MINIMO	MIN SET-UP SPREAD	MIN ABSTÜTBREITE	STABILISATION MINI	3.730 MM

Palazzani
INDUSTRIE SPA

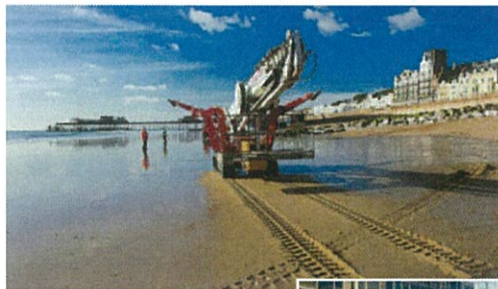
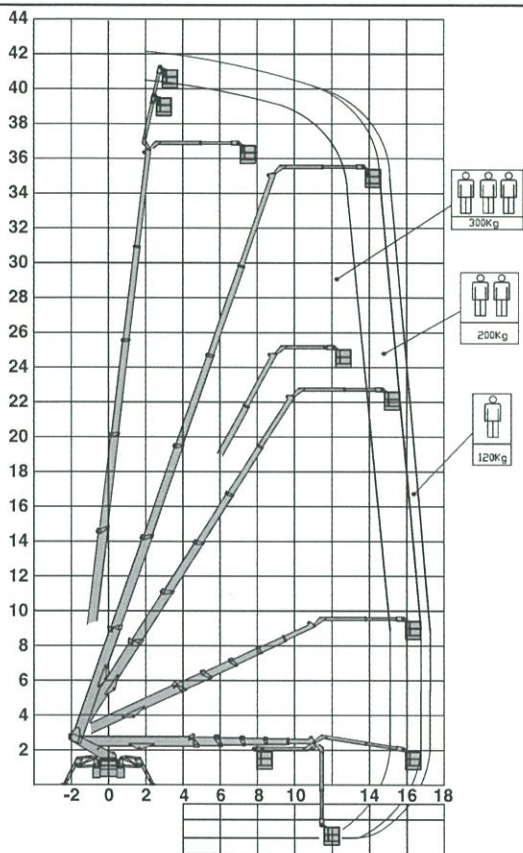
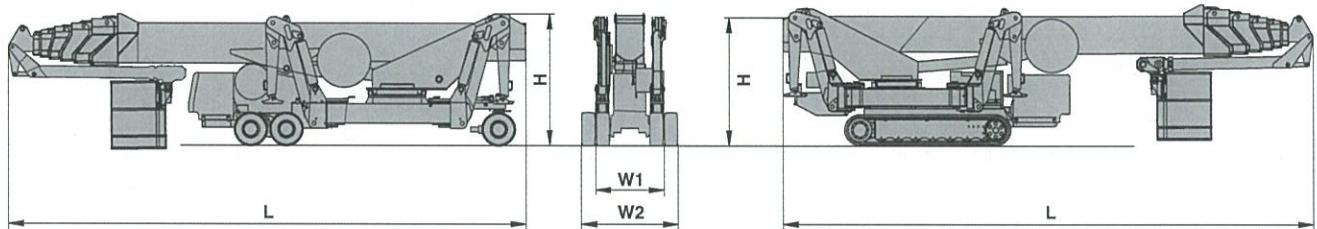
25050 Paderno F.C. (BS) - Italy
Tel ++ 39 030 6857073 - Fax ++ 39 030 657079
platforms@palazzani.it - www.palazzani.it

COMPANY WITH QUALITY MANAGEMENT
SYSTEM CERTIFIED BY DNV
= ISO 9001:2008 =

R362A